

Studio Kona

All Hydro Systems Builder's Series bathtubs and whirlpools are backed by our exclusive 5 year limited warranty and include the standard features.

Available Sizes:

60"L x 36"W x 15"D
35 Gallons

60"L x 42"W x 15"D
40 Gallons

60"L x 42"W x 18"D
45 Gallons

60"L x 42"W x 20"D
45 Gallons



Builder Model Feature:

White/Almond/Bone/Natural
 Gelcoat Bathtub
 Integral Wood Base
 Integral skirt (no access panel)
 Tile Flange - molded
 6 Jets Adjustable/Directional
 Air Switch
 Silent Air Induction
 Anti-Vortex Safety Suction
 1¼ hp UL Listed Pump, mounted
 Sturdy Cardboard Box

Optional Equipment

Available as Tub only, Thermal Air, Whirlpool

Inline Heater

Waste & Overflow

- Polished Chrome
- Polished Brass

System Trim

- Polished Chrome
- Polished Brass

Hydro Coat

Hydro Express Quick Ship

Approvals & Listings

Commonwealth of Massachusetts
 UPC & USPC - US & Canada

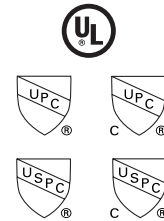

Electrical Component

Electrical Requirements





Whirlpool (1.25 HP Single Speed Pump, 120V)	1 Dedicated 20 Amp GFCI Circuit
Thermal Air (1 HP Blower with 600 Watt Heater)	1 Dedicated 20 Amp GFCI Circuit
Inline Heater	
600 W	Shares Pump Circuit
1500 W	1 Dedicated 20 Amp GFCI Circuit

Studio Kona

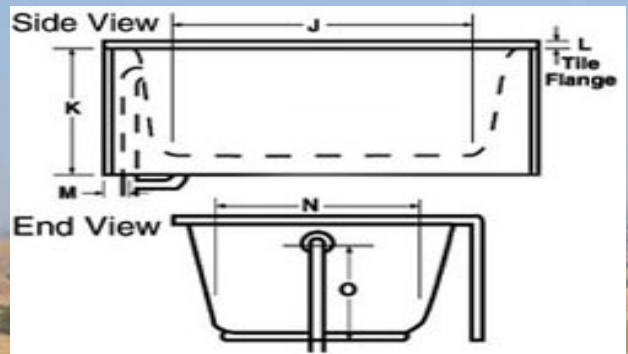
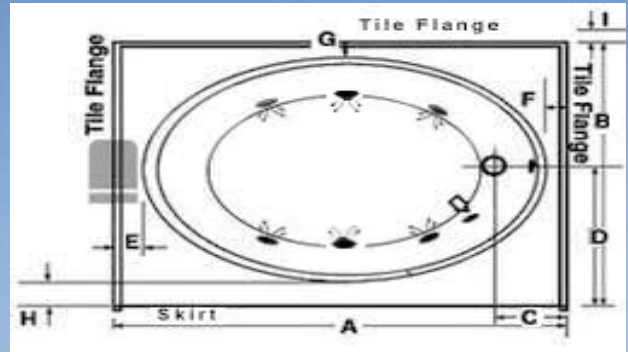

Must be set in Mortar Base



-  Pump motor
-  Jets
-  Anti-vortex suction
-  Overflow location

AS SHOWN:
Whirlpool option w/ standard jets

ALSO AVAILABLE:
Soaking Tub Only, Thermal Air,

Model	GC	AC	A	B	C	D	E	F	G	H	I	J	K	L	M	N	O	Jet	Pump	Wat.Cap.
6036-15	N/A	√	60"	36"	9"	18"	3"	3"	4"	4"	1"	46"	15"	1½"	2½"	22"	12½"	6	1.25	35 gal.
6042-15	N/A	√	60"	42"	11"	21"	3"	4"	4"	4½"	1"	43"	15"	1"	3"	24"	12½"	6	1.25	40 gal.
6042-18	N/A	√	60"	42"	11"	21"	3"	4"	4"	4½"	1"	43"	18"	1"	3"	24"	14¾"	6	1.25	45 gal.
6042-20	N/A	√	60"	42"	11"	21"	4"	4"	4"	4½"	1"	43"	20"	1"	3"	24"	14¾"	6	1.25	45 gal.

Framing Dimensions

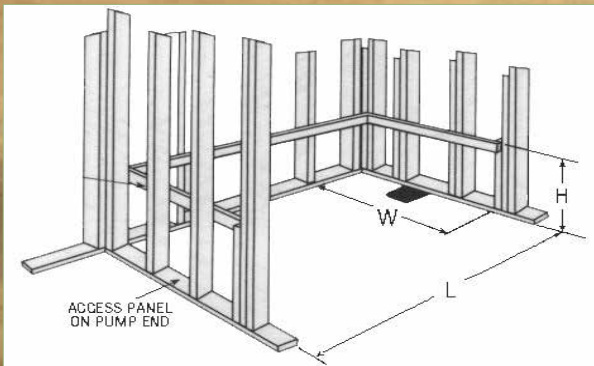

3 Wall Enclosure

Model	(L)ength	(W)idth	(H)eight Finish
6036-15	60"	36"	14¾"
6042-15	60"	42"	14¾"
6042-18	60"	42"	17¾"
6042-20	60"	42"	19¾"

*Disclaimer: Certain options or altering the pump/blower location may cause the pump/blower to extend beyond the tub decking.
 For cutout dimensions wait for unit to arrive.
 All specifications subject to change without notice.*