

206-2.2M-__

Wall Mounted 3 Hole Lavatory Set
Requires SS-THV2.2 concealed rough
Flow Rate: 1.2 GPM

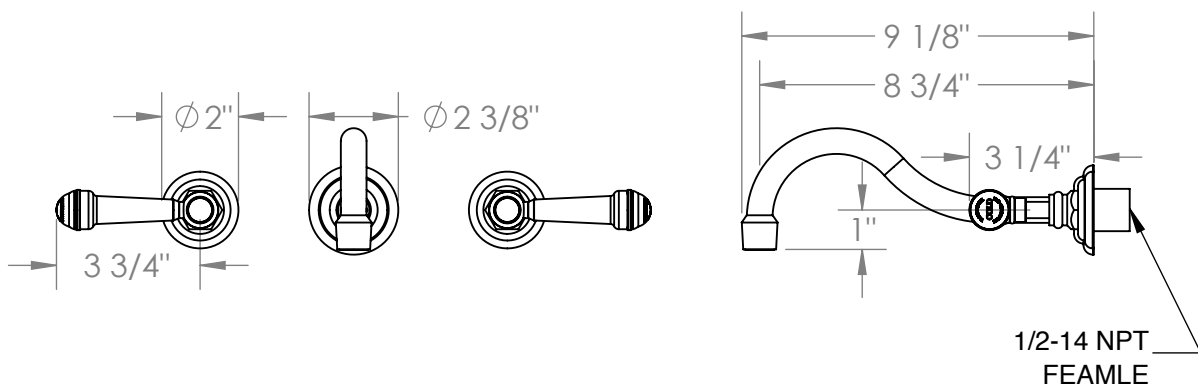

Meets the applicable requirements of ASME A112.18.1-2005/CSA B125.1-05, entitled "Plumbing Supply Fittings"

WATERMARK DESIGNS 8/15/2019

350 Dewitt Ave Brooklyn NY 11207 USA T 718 257 2800 F 718 257 2144 info@watermark-designs.com

HANDLE TRIM OPTIONS

S1 - PRESTON

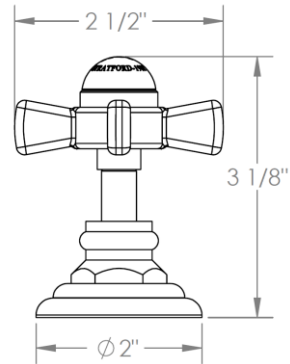

S2 - WALTHAM

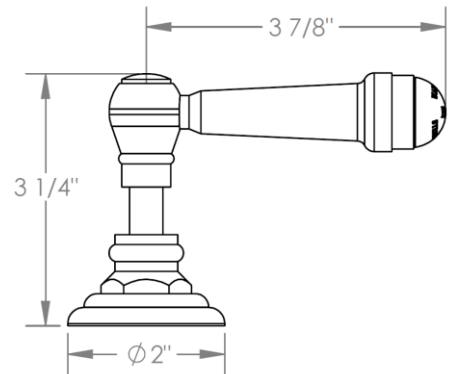

SWA - DARIEN

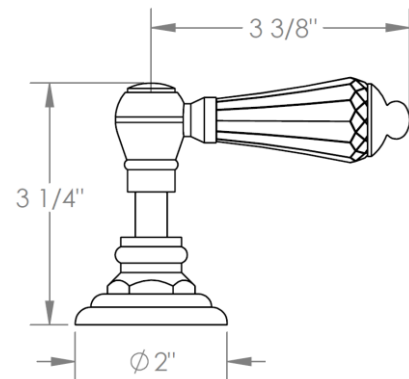

V - WALES

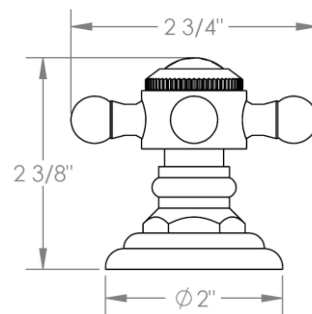

S1A – NOTTINGHAM

